

snake



OIL & STEEL
AERIAL PLATFORMS

ENG FRA DEU NED

snake

OIL & STEEL
AERIAL PLATFORMS

MENU

*SNAKE SERIE / SÉRIE SNAKE
SERIE SNAKE / SERIE SNAKE*

SNAKE 189

SNAKE 2112

*SNAKE PLUS SERIE / SÉRIE SNAKE PLUS
SERIE SNAKE PLUS / SERIE SNAKE PLUS*

SNAKE 1770 PLUS

SNAKE 2010 PLUS

SNAKE 2413 PLUS

SNAKE 2612 PLUS

SNAKE 2815 PLUS

*SPECIFICATIONS / SPÉCIFICATIONS
SPEZIFIKATIONEN / SPECIFICATIES*

snake



snake

ENG

POWER GETS SMART

The Snake line includes articulated platforms with simple or double pantograph. With this design it is possible to move straight up and then extend over any obstacles at height. All models are fitted with a rotation system on a slew ring.

HIGHLY COMPACT:

Snake aerial platforms stand out with the compact size of the trucks when stowed for travel.

HIGH PERFORMANCE:

the continuous technological innovation of Snake models led to an increase of the maximum capacity from 200 to 225 kg on models with a single articulation and a maximum capacity of 250 kg on the Snake 2010 Plus model.

FRA

LA PUISSANCE FAIT SMART

La série Snake est composée de nacelles articulées avec simple ou double pantographe, grâce auquel il est possible de soulever la charnière d'articulation du bras de travail afin de franchir facilement les obstacles en hauteur. Un système de rotation sur sellette est prévu sur tous les modèles de la gamme Snake.

TRES FAIBLE ENCOMBREMENT:

Les nacelles de la série Snake se distinguent par leur faible encombrement, en phase de travail.

PERFORMANCE MAXIMALE:

L'innovation technologique, qui a été apportée continuellement aux modèles de la gamme Snake a permis d'augmenter la charge maximale dans le panier ; en passant ainsi de 200 à 225 kilos sur les modèles à simple, et en atteignant une portée maximum de 250kg dans le panier sur le modèle Snake 2010 Plus.



snake

DEU

DIE LEISTUNG WIRD SMART

Die Serie Snake umfasst Gelenkarbeitsbühnen mit einfachem oder doppeltem Pantographen, der ermöglicht, das Gelenk des Arbeitsauslegers nach oben auszufahren und so Hindernisse in der Höhe zu überwinden. Alle Modelle sind mit einer Drehvorrichtung auf Drehkranz ausgestattet.

SUPERKOMPACTE BAUWEISE:

Die Arbeitsbühnen Snake zeichnen sich durch geringe Abmessungen des Fahrzeugs aus, auf dem sie montiert werden.

HÖCHSTLEISTUNGEN:

Die ständige technologische Innovation der Modelle Snake hat bei den Modellen mit einfachem Gelenk zu einer Steigerung der maximalen Tragkraft von 200 auf 225 kg und beim Modell Snake 2010 Plus zu einer maximalen Tragkraft von 250 kg geführt.

NED

KRACHT WORDT 'SMART'

De Snake-serie bestaat uit knikkende hoogwerkers met een enkele of dubbele pantograaf. Dit ontwerp maakt het mogelijk om recht omhoog te bewegen en vervolgens in de hoogte over eventuele obstakels heen te reiken. Alle modellen zijn voorzien van een draaisysteem op een draaikrans.

UITERST COMPACT:

De Snake hoogwerkers onderscheiden zich door de compacte omvang van de trucks als de platforms ingetrokken zijn voor het rijden.

HOGHE PRESTATIES:

De voortdurende technologische innovatie van de Snake-modellen heeft geleid tot een verhoging van de maximumcapaciteit van 200 tot 225 kg op modellen met één scharnierpunt, en van 250 kg op het model Snake 2010 Plus.

OIL & STEEL
AERIAL PLATFORMS



snake

ENG

SAFETY IN EVERY DETAIL

STABILIZATION:

The models in the Snake Series can be stabilized in confined spaces ensuring the greatest operator safety thanks to the safety devices they are fitted with.

STURDY AND PROTECTED:

New design and new materials for the protective covers of the controls give the Snake's product line increased strength and durability over time, as well as protection of the devices during the platforms ordinary use.

MAXIMUM CONTROL, MAXIMUM SAFETY:

Advanced safety systems which comply with the new regulations.



FRA

SÉCURITÉ DANS LE MOINDRE DÉTAIL

STABILISATION:

Les modèles de la série Snake peuvent être stabilisés dans des espaces réduits, mais grâce à leurs dispositifs de sécurité, ils assurent la sûreté maximale de l'opérateur.

PROTECTION ET SOLIDITE:

Le nouveau design et les nouveaux matériaux utilisés pour l'élaboration du carter de protection des commandes confèrent à la série Snake une meilleure résistance ainsi qu'une plus grande solidité à travers le temps, en plus d'une protection des dispositifs pendant l'utilisation habituelle de la nacelle.

SYSTEME DE CONTRÔLE MAXIMUM POUR UNE SECURITE MAXIMALE:

Toutes nos machines sont dotées de systèmes de sécurité évolués, conformes aux nouvelles normes.



snake

DEU

SICHERHEIT IN JEDEM DETAIL

STABILISIERUNG:

Die Modelle der Serie Snake erfordern nur eine geringe Stützfläche zur Stabilisierung bei maximaler Sicherheit für den Bediener dank der installierten Sicherheitseinrichtungen.

ROBUST UND SICHER:

Die neue Bauweise und die neuen Werkstoffe der Schutzgehäuse der Bedienelemente verleihen der Linie Snake neben dem Schutz der Geräte während des Betriebs höhere Dauerhaftigkeit und Robustheit.

MAXIMALE STEUERUNG, HÖCHSTE SICHERHEIT:

Moderne und den neuen Bestimmungen entsprechende Sicherheitssysteme.



NED

VEILIGHEID IN ELK DETAIL

STABILISATIE:

De modellen van de Snake-serie kunnen in kleine ruimten, en dankzij de veiligheidsinrichtingen die erop aanwezig zijn, uiterst veilig voor de bediener worden gestabiliseerd.

ROBUUST EN BESCHERMD:

Voor de beschermkappen van de bedieningselementen zijn een nieuw ontwerp en nieuwe materialen gebruikt, waardoor de Snake productlijn sterker en duurzamer wordt en deze inrichtingen tijdens het normale gebruik van de hoogwerker beter worden beschermd.

MAXIMALE CONTROLE, MAXIMALE VEILIGHEID:

Geavanceerde veiligheidssystemen conform de nieuwe regelgeving.



OIL & STEEL
AERIAL PLATFORMS

snake 189

snake 2112

ENG

SMALL IS BIGGER

MAXIMUM CONTROL MAXIMUM SAFETY:

Further improvement of the electro-hydraulic system to better align with the rest of the product range. Meaning these models offer advanced safety systems and comply with the new regulations.

ADVANCED PERFORMANCE WITH MINIMUM DIMENSIONS:

- Capacity up to 225 kg
- Rotation system on slew ring with rotation angle of 400°

In addition, an important innovation concerning the stabilization system of the 2112 model, which no longer provides the rear extendible cross members. This ensures maximum performance, with a minimum stabilization surface, in addition to ease of use and significant time savings for the operator.

FRA

PETIT DEVIENT GRAND

SYSTEME DE CONTRÔLE MAXIMUM POUR UNE SECURITE MAXIMALE:

Dernièrement, des améliorations de l'installation électro hydraulique ont été réalisées, afin de mieux cadrer avec les caractéristiques techniques des autres modèles de la gamme. Ces modèles garantissent donc eux aussi un système de sécurité maximal, conformément aux normes en vigueur.

FAIBLE ENCOMBREMENT ET PERFORMANCES AVANT-GARDISTES:

- Portée maximale: 225kg
- Système de rotation sur sellette avec un angle de rotation à 400°

De plus, une innovation importante a été apportée au système de stabilisation du modèle 2112 : ce dernier ne prévoit plus les traverses extensibles à l'arrière.

Cela garantit de meilleures prestations et un plan de stabilisation simplifié et donc une grande simplicité d'utilisation, mais aussi un gain de temps non négligeable pour l'opérateur.





snake 189
snake 2112

DEU

KLEIN IST GROß

MAXIMALE STEUERUNG, HÖCHSTE SICHERHEIT:

Durch weitere Verbesserungen ist die Elektrohydraulik jetzt den Merkmalen der übrigen Modelle angepasst. Auch diese Modelle bieten jetzt ein Sicherheitssystem der Spitzenklasse, die alle Anforderungen der neuen Bestimmungen erfüllen.

SPITZENLEISTUNGEN BEI MINIMALLEN ABMESSUNGEN:

- Maximale Tragkraft von 225 kg
- Rotationsvorrichtung auf Drehkranz mit Drehwinkel von 400°

Eine wichtige Innovation betrifft das System der Stabilisierung des Modells 2112, das nicht mehr über die hinteren ausziehbaren Querträger verfügt. Das gewährleistet neben einfacher Benutzung und beträchtlicher Zeitersparnis für den Bediener maximale Leistungen bei minimaler Stützfläche für die Stabilisierung.

NED

KLEIN IS GROTER

MAXIMALE CONTROLE, MAXIMALE VEILIGHEID:

Een verdere verbetering van het elektrohydraulische systeem voor een betere uitlijning met de rest van het productenscala. Dit betekent dat deze modellen geavanceerde veiligheidssystemen bieden en voldoen aan de nieuwe regelgeving.

GEAVANCEERDE PRESTATIES BIJ DE GERINGSTE AFMETINGEN:

- Capaciteit tot 225 kg
- Draaisysteem op een draaikrans met een draaihoek van 400°

Bovendien een belangrijke innovatie in het stabilisatiesysteem van het model 2112, die niet langer de uitschuifbare dwarselementen aan de achterkant heeft. Behalve het gebruiksgemak en de aanzienlijke tijdsbesparing voor de bediener waarborgt dit maximale prestaties bij een minimaal stempeloppervlak.



snake plus



snake plus

ENG

METROPOLITAN FLEXIBILITY

COMFORT IN CITY TRAFFIC.

ULTRA COMPACT:

Snake Plus is a series of aerial platforms developed to better respond to the need of working in the city. The main features of this line:

- Stabilization within limited space and with the possibility of stabilization in the vehicle shape;
- Cantilevered head extremely limited in order to avoid the risk of collision with transiting vehicles;
- Dual access: from closed platform and from the ground;
- Extremely compact.

THE REAL DOUBLE PANTOGRAPH:

The Snake Plus series is the only platform line featuring a double pantograph, with the geometry and movement kinematics, allows to make a perfectly vertical up/down platform movement, specifically it is able to raise/lower the platform following a vertical straight line. This results in a drastic reduction of the positioning time as the typical multiple manoeuvres associated with platforms not equipped with the same system are eliminated.

FRA

FLEXIBILITÉ POUR LA VILLE

ULTRA COMPACTES. ELLES S'ADAPTENT PARFAITEMENT A L'ENVIRONNEMENT URBAIN:

La série Snake comprend une gamme de nacelles conçues pour répondre au mieux au besoin de travail en environnement urbain.

En voici les raisons principales:

- Elles sont équipées d'un système de stabilisation à encombrement réduit (possibilité de « stabilisation étroite »);
- Le dépassement de la tête extrêmement limité afin d'éviter les risques de collisions avec les autres véhicules lors des déplacements;
- Double accès à la nacelle: par le châssis de la nacelle ou directement par le panier au sol;
- Extrêmement compactes.

LE VÉRITABLE DOUBLE PANTOGRAPHE:

La série Snake (duo) est la seule et unique à disposer d'un double pantographe, dont les caractéristiques techniques, permettent de réaliser une réelle montée et descente du bras « à fil à plomb ».

Cela permet de lever et d'abaisser le panier en suivant une ligne verticale rectiligne.

Ce système réduit donc considérablement les temps de positionnement, en éliminant les nombreuses manœuvres qu'il faut habituellement effectuer sur les nacelles, qui ne sont pas équipées de double pantographe.



DEU

METROPOLITANISCHE FLEXIBILITÄT

WENDIGKEIT IM STANDTVERKEHR. ULTRAKOMPAKT:

Snake (DUO) ist eine Serie von Arbeitsbühnen, die für die bei Einsätzen im Stadtbereich gestellten Anforderungen konzipiert ist. Die Hauptmerkmale der Linie sind:

- Stabilisierung mit reduziertem Platzbedarf und der Möglichkeit variabler Stabilisierung;
- Der stark reduzierte Kopfüberhang beugt der Kollisionsgefahr mit anderen Fahrzeugen vor;
- Doppelter Zugang: von der geschlossenen Arbeitsbühne und vom Boden;
- Extrem kompakte Bauweise.

DER WAHRE DOPPEL-PANTOGRAPH:

Die Serie Snake Plus ist die einzige Arbeitsbühnenlinie mit einem Doppelpantographen, dessen Geometrie und Bewegungskinetik ein echtes "lotrechtes" Heben/Senken erlauben, d.h. die fähig ist, den Korb in einer vertikalen geraden Linie zu heben/senken. Das Ergebnis ist eine drastische Reduzierung der Positionierungszeiten, da die vielfältigen typischen Manöver wegfallen, die bei Arbeitsbühnen ohne dieses System erforderlich sind.

NED

METROPOLITAANSE FLEXIBILITEIT

COMFORTABEL IN HET STADSVERKEER.

ULTRA COMPACT:

Snake Plus is een serie hoogwerkers die ontwikkeld is om beter in te gaan op de eisen bij het werken in de stad. Dit zijn de belangrijkste kenmerken van deze lijn:

- Stabilisatie in beperkte ruimten en met de mogelijkheid van stabilisatie binnen de voertuigomtrek;
- Zeer beperkte overhang van de kop, om het gevaar voor botsingen met voorbijrijdende voertuigen te vermijden;
- Twee toegangen: vanaf het gesloten platform en vanaf de grond;
- Uiterst compact.

DE ECHTE DUBBELE PANTOGRAAF:

De Snake Plus-serie is de enige platformlijn met een dubbele pantograaf waarvan de geometrie en de kinematica van de bewegingen een perfect verticale beweging omhoog en omlaag van het platform mogelijk maken, d.w.z. dat het mogelijk is het platform met een rechte verticale lijn te laten stijgen/dalen. Het resultaat hiervan is een drastische reductie van de positioneringstijd, aangezien de typische verschillende manoeuvres van platforms die niet voorzien zijn van dit systeem, worden geëlimineerd.



snake 1770 plus

ENG

IN-SIZE STABILISATION

The main feature of Snake 1770 Plus is the stabilization system in the vehicle shape that allows the operator to position the vehicle in a normal city street side parking space, thus avoiding the need to occupy the street. Snake 1770 Plus is able to reach 17.1 m in height and 7.3 m of maximum outreach with platform maximum load of 220 kg (2 operators + tools). Platform installed on short wheelbase truck (2900 mm) for better manoeuvrability in the city traffic.

FRA

STABILISATION DANS LE GABARIT

La caractéristique principale de la Snake 1770 Compact Re est son système de « stabilisation étroite » qui permet de stabiliser le véhicule dans des rues, sans pour autant empiéter sur la voie publique.

La Snake 1770 Compact Re a une hauteur de travail maximale de 17,1m, un déport maximum de 7,3 m ainsi qu'une portée maximale de 220 kg dans le panier (soit 2 opérateurs + outillage)

La nacelle est montée sur un camion à empattement court (2900 mm) afin de faciliter considérablement les manœuvres en milieu urbain.





snake 1770 plus

DEU

IN-FORM STABILISIERUNG

Das Hauptmerkmal der Snake 1770Plus ist die Abstützung in der Fahrzeugkontur, die es ermöglicht auf einem normalen stätischen Parkplatz oder am Straßenrand zu arbeiten, ohne die Fahrbahn zu blockieren. Snake 1770 Plus ist in der Lage, eine Höhe von 17,1 m zu erreichen und verfügt über eine maximale Reichweite von 7,3 m bei maximaler Belastung des Korbs mit 220 kg (2 Bediener + Werkzeuge). Arbeitsbühne auf Lastkraftwagen mit kurzem Achsstand (2900 mm) für bessere Wendigkeit im Stadtverkehr.

NED

STABILISATIE BINNEN DE OMTREK

Het belangrijkste kenmerk van de Snake 1770 Plus is het stabilisatiesysteem binnen de voertuigomtrek, waardoor de bediener het voertuig op een gewone parkeerplek in een straat in de stad kan zetten, zonder de weg te hoeven bezetten. De Snake 1770 Plus kan 17,1 m ver reiken in de hoogte en maximaal 7,3 m naar buiten, bij een maximale belasting van het platform van 220 kg (2 bedieners + gereedschappen). Voor een betere behendigheid in het stadsverkeer is het platform gemonteerd op een truck met korte wielbasis (2900 mm).



snake 2010 plus

ENG

RENTAL WITHOUT OPERATOR

Snake 2010 Plus is the OIL&STEEL model specifically designed for rental without operator. It is characterized by its extreme lightness and compact size. The platform is equipped with an "A" stabilization system which is very simple to use, even by inexperienced operators.

With fully hydraulic controls, this model is characterized by reliability and lower maintenance costs.

Snake 2010 Plus is equipped with a slew ring rotation of 360° (not continuous) that allows to work even on the front of the cabin. This model is able to reach 20 m maximum working height and 10.2 m lateral outreach (with a capacity of 120 kg); 8 meters with a capacity of 250 Kg.

Fitted on a truck with a wheelbase of 3400 mm, Snake 2010 Plus measures only 2400 mm in height and 6300 mm in length.

FRA

LOCATION SANS CHAUFFEUR

La Snake 2010 (duo) est le modèle de nacelles Oil&Steel qui a été rigoureusement pensé pour la location sans chauffeur. Le modèle se distingue par sa grande légèreté et son incroyable compacité. La nacelle est équipée d'un système de stabilisation en A très simple d'utilisation, même pour les utilisateurs novices.

Avec ses commandes entièrement hydrauliques, le modèle se caractérise par sa fiabilité et ses faibles coûts de manutention.

La Snake 2010 a une rotation sur sellette de 360° (non continue), ce qui permet donc à l'opérateur de travailler en avant de la cabine.

Ce modèle a une hauteur de travail maximum de 20 mètres, un déport latéral de 10.2 m (avec une portée maximale de 120 kg dans le panier). Toutefois, avec une charge de 250 kilos dans le panier, ce modèle offre encore un déport horizontal de 8 mètres.

Montée sur un camion à empattement 3400 mm, la nacelle Snake 2010 Plus mesure seulement 2400 mm de haut pour une longueur totale de 6300 mm.



DEU

MIETEN OHNE FAHRER

Snake 2010 Plus ist das Modell von OIL&STEEL, das ausdrücklich für die Branche der fahrerlosen Vermietung bestimmt ist. Das Modell besticht durch extreme Leichtigkeit und kompakte Bauweise. Die Arbeitsbühne ist mit einem System mit A-Stabilisatoren versehen, das auch von wenig erfahrenen Bedienern leicht zu benutzen ist.

Das voll hydraulisch gesteuerte Modell zeichnet sich durch Zuverlässigkeit und geringe Wartungskosten aus. Snake 2010 Plus ist mit einer Rotation auf Drehkranz bis 360° (nicht kontinuierlich) versehen, die das Arbeiten auch auf der Frontseite der Kabine erlaubt. Das Modell erreicht eine maximale Arbeitshöhe von 20 m und hat eine seitliche Reichweite von 10,2 m (mit einer Tragkraft von 120 kg); 8 Meter bei Tragfähigkeit von 250 kg.

Bei Installation auf einem LKW mit Achsstand von 3400 mm weist Snake 2010 Plus eine Höhe von 2400 mm und eine Länge von 6300 mm auf.

NED

HUREN ZONDER BEDIENER

De Snake 2010 Plus is het OIL&STEEL-model dat specifiek is ontworpen voor verhuur zonder bestuurder. Hij wordt gekenmerkt door zijn extreme lichtheid en compacte omvang. Het platform is uitgerust met een stabilisatiesysteem "A" dat ook door onervaren bedieners zeer gemakkelijk te gebruiken is.

Met volledig hydraulische bedieningselementen wordt dit model gekarakteriseerd door een grote betrouwbaarheid en lagere onderhoudskosten.

De draaikrans van de Snake 2010 Plus kan 360° draaien (niet traploos) waardoor er zelfs aan de voorkant van de cabine kan worden gewerkt. Dit model kan een werkhoogte van maximaal 20 m bereiken en heeft een zijdelingse reach van 10,2 m (met een capaciteit van 120 kg); 8 meter met een capaciteit van 250 kg. Als hij gemonteerd is op een truck met een wielbasis van 3400 mm, heeft de Snake 2010 Plus een hoogte van 2400 mm en lengte van 6300 mm.



snake 2010 plus

ITA

H STABILIZATION

NEW:

Derived from Snake 2010 Plus, the new Snake 2010 Plus H is even more lightweight and compact. In fact it is installed on short wheelbase (2900 mm) and has a length of only 5900 mm.

FRONT H STABILIZATION:

Equipped with front extensible stabilizers with H outriggers, can operate with maximum flexibility and high performance even in tight spaces. It can also be stabilized in the vehicle transport configuration.



FRA

SYSTEME DE STABILISATION EN H

NOUVEAUTE:

Inspirée par la Snake 2010 Plus, la nouvelle Snake 2010 Plus H est encore plus légère et plus compacte.

En effet, la partie aérienne est installée sur un porteur à empattement court (2900 mm) dont la longueur est de 5900 mm seulement.

STABILISATION EN H:

Equippée à l'avant de stabilisateurs extensibles en H la nacelle offre une grande flexibilité et des performances maximales, même dans des espaces de travail restreints.

La nacelle peut également être stabilisée dans le gabarit du véhicule en position de transport.



snake 2010 plus

DEU

H-STABILISATOREN

NEU:

Das aus dem Modell Snake 2010 Plus abgeleitete neue Modell Snake 2010 Plus H ist noch leichter und kompakter. Es wird auf einem LKW mit kurzem Achsstand (2900 mm) montiert und hat eine Länge von nur 5900 mm. Er kann auch stabilisiert werden in der transport aufstellung des Fahrzeuges.

H STABILIZIERUNG AN DIE VORDERSEIFE:

Es ist mit vorderen ausziehbaren Querträger konzipiert, um die Höchstleistungen aufrecht zu erhalten.



NED

H-STABILISATIE

NIEUW:

De nieuwe Snake 2010 Plus H is afgeleid van de Snake 2010 Plus, en nog lichter van gewicht en compacter. Hij is geïnstalleerd op een korte wielbasis (2900 mm) en heeft een lengte van slechts 5900 mm.

H-STABILISATIE AAN DE VOORZIJD:

Aangezien dit model is uitgerust met uitschuifbare stempels aan de voorzijde met H-uithouders, kan het, ook in nauwe ruimten, werken met een maximale flexibiliteit en hoge prestaties. Hij kan ook worden gestabiliseerd in de transportopstelling van het voertuig.



snake 2413 plus

snake 2612 plus

ENG

LIGHT AND POWERFUL

HIGH PERFORMANCE WITH B DRIVING LICENSE:

Top performance of the sector, compact size, precision and safety of the platform movements are the main features of these two models.

The model Snake 2413 Plus can reach a working height of approximately 23.5 meters, with an outreach of almost 12.6 meters (80 kg); while the model Snake 2612 Plus can reach a working height of 25.5 meters and an outreach of more than 12 meters (80 kg).

REDUCED WEIGHT, GREATER STRUCTURAL STIFFNESS:

The use of high strength steels of the latest generation, combined with the identification of particular geometries, has allowed to reduce the weight of the extensible structure whilst ensuring high stiffness and strength.

FRA

LÉGÈRES ET PUISSANTES

GRANDES PERFORMANCES SUR VEHICULES LEGERS:

Performance au top dans le secteur, dimensions réduites, précision et sécurité. Voici les mots d'ordre de ces deux modèles.

Le modèle Snake 2413 Plus peut atteindre une hauteur de travail de 23.5 mt avec une portée d'environ 12.6 mt (avec 80 kg).

En revanche, le modèle Snake 2612 Plus a quant à lui une hauteur de travail maximum d'environ 25.5 mètres pour un déport horizontal de 12 mètres (toujours avec une charge de 80 kg dans le panier).

POIDS REDUITS ET PLUS GRANDE COMPACTE:

L'utilisation d'aciers haute résistance ainsi que la création de géométries particulières ont permis d'alléger la partie aérienne, tout en assurant une solidité et une résistance maximales.



snake 2413 plus

snake 2612 plus

DEU

LEICHT UND LEISTUNGSSTARK

SPITZENLEISTUNGEN MIT FÜHRERSCHEIN B:

Spitzenleistungen der Branche, geringe Abmessungen, Genauigkeit und Sicherheit der Bewegungen sind die wichtigsten Eigenschaften dieser beiden Modelle.

Das Modell Snake 2413 Plus kann eine Arbeitshöhe von ca. 23,5 Metern erreichen bei einer Reichweite von fast 12,6 Metern (mit 80 kg); das Modell Snake 2612 Plus erreicht dagegen eine Arbeitshöhe von 25,5 Metern bei einer Reichweite von über 12 Metern (mit 80 kg).

REDUZIERTES GEWICHT, HÖHERE STRUKTURELLE STEIFIGKEIT:

Die Verwendung hochfester Stähle neuester Generation in Verbindung mit besonderen Geometrien hat die Reduzierung des Gewichtes der ausziehbaren Struktur unter Beibehaltung der beträchtlichen Steifigkeit und Dauerhaftigkeit ermöglicht.

NED

LICHT EN KRACHTIG

HOGHE PRESTATIES MET EEN B-RIJBEWIJS:

Topprestaties in de sector, compacte maat, nauwkeurigheid en veiligheid van de platformbewegingen zijn de belangrijkste kenmerken van deze twee modellen.

Het model Snake 2413 Plus kan een werkhoopte bereiken van ongeveer 23,5 meter, met een reikwijdte van bijna 12,6 meter (80 kg); terwijl het model Snake 2612 Plus een werkhoopte kan bereiken van 25,5 meter en een reikwijdte van meer dan 12 meter (80 kg).

LAGER GEWICHT, GROTERE STIJFHEID VAN DE CONSTRUCTIE:

Door het gebruik van hoogwaardig staal van de laatste generatie, gecombineerd met de identificatie van bijzondere geometrieën werd het mogelijk het gewicht van de uitschuifconstructie te verlagen terwijl er een grote stijfheid en sterkte worden gewaarborgd.



snake 2413 plus

snake 2612 plus

ENG

PRECISE & STURDY

ACCURACY AND SAFETY:

The command (electro-hydraulic) and control system of the booms ensures very gradual and precise movement.

FRONT H STABILIZATION:

Equipped with front extensible stabilizers with H outriggers, both models can operate with maximum flexibility and high performance even in tight spaces. The two platforms can also be stabilized in the vehicle transport configuration.

FRA

PRÉCISES ET SOLIDES

PRECISION ET SECURITE:

Le système de commande (électro-hydraulique) et de contrôle de la faux-chassis assure une progression et une précision parfaite des mouvements.

STABILISATEURS ARRIERE EN H:

Equipée à l'arrière, de traverses extensibles avec stabilisateurs en H, ces deux modèles peuvent travailler avec une flexibilité et des performances maximales même dans des espaces restreints.

Le système de «stabilisation étroite» est également inclus sur ces deux modèles.



snake 2413 plus

snake 2612 plus

DEU

PRÄZISE UND ROBUST

PRÄZISION UND SICHERHEIT:

Die (elektrohydraulische) Bedienung und die Steuerung des Unterbaus gewährleisten hervorragende Abstufung und Genauigkeit der Bewegungen.

VORDERE H-STABILISATOREN:

Dank der vorderen Ausstattung mit ausziehbaren Querträgern mit H-Stabilisatoren weisen beide Modelle maximale Flexibilität und herausragende Leistungen bei beengten Platzverhältnissen auf. Beide Arbeitsbühnen können auch mit variabler Abstützung stabilisiert werden.

NED

NAUWKEURIG EN ROBUUST

NAUWKEURIGHEID EN VEILIGHEID:

De (elektrohydraulische) bedieningselementen en het besturingssysteem van de armen verzekeren een zeer geleidelijke, nauwkeurige beweging.

H-STABILISATIE AAN DE VOORZIJDE:

Omdat beide modellen zijn uitgerust met uitschuifbare stempels aan de voorzijde met H-uithouders, kunnen ze ook in nauwe ruimten werken met een maximale flexibiliteit en hoge prestaties. De twee platforms kunnen ook worden gestabiliseerd binnen de omtrek van het voertuig.



snake





3

- 1 Front Stabiliser
- 1 Stabilisateur antérieur
- 1 Stabilisator
- 1 Stempelpoten

- 2 Sumps and high controls on cage
- 2 Carter et commandes sur panier
- 2 Abdeckung und steuerung am Arbeitskorb
- 2 Bedieningskast in de basket

- 3 Low stabilisation controls
- 3 Commandes pour stabilisation en bas
- 3 Notsteuerungen unten
- 3 Bedienung voor de stempelpoten

- 4 New protective cover of the controls
- 4 Nouveau carter de protection des commandes
- 4 Neue Schutzabdeckung der Bedienelemente
- 4 Nieuwe beschermkap voor de bediening

- 5 Rotation system on fifth wheel
- 5 Système de rotation continue sur sellette
- 5 Rotationssystem: Sattelkupplung
- 5 Rotatiesysteem op het 5e (vijfde) wiel

- 6 Safety sensors PLE closed
- 6 Capteurs de sécurité PLE repliée
- 6 Sicherheitsüberwachung: Arbeitsbühne in Transportstellung
- 6 Veiligheidssensoren PLE gesloten



6

SPECIFICATIONS

SPÉCIFICATIONS

SPEZIFIKATIONEN

SPECIFICATIES





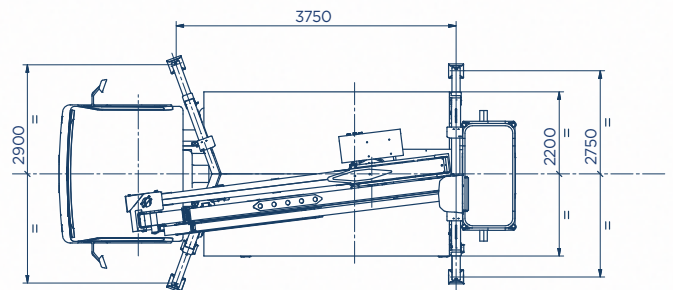
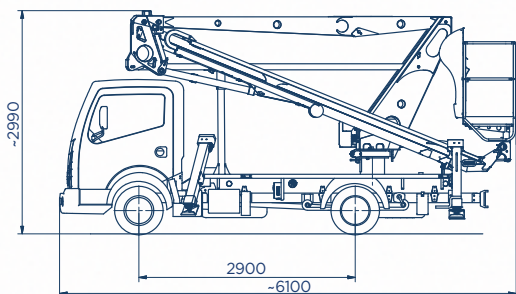
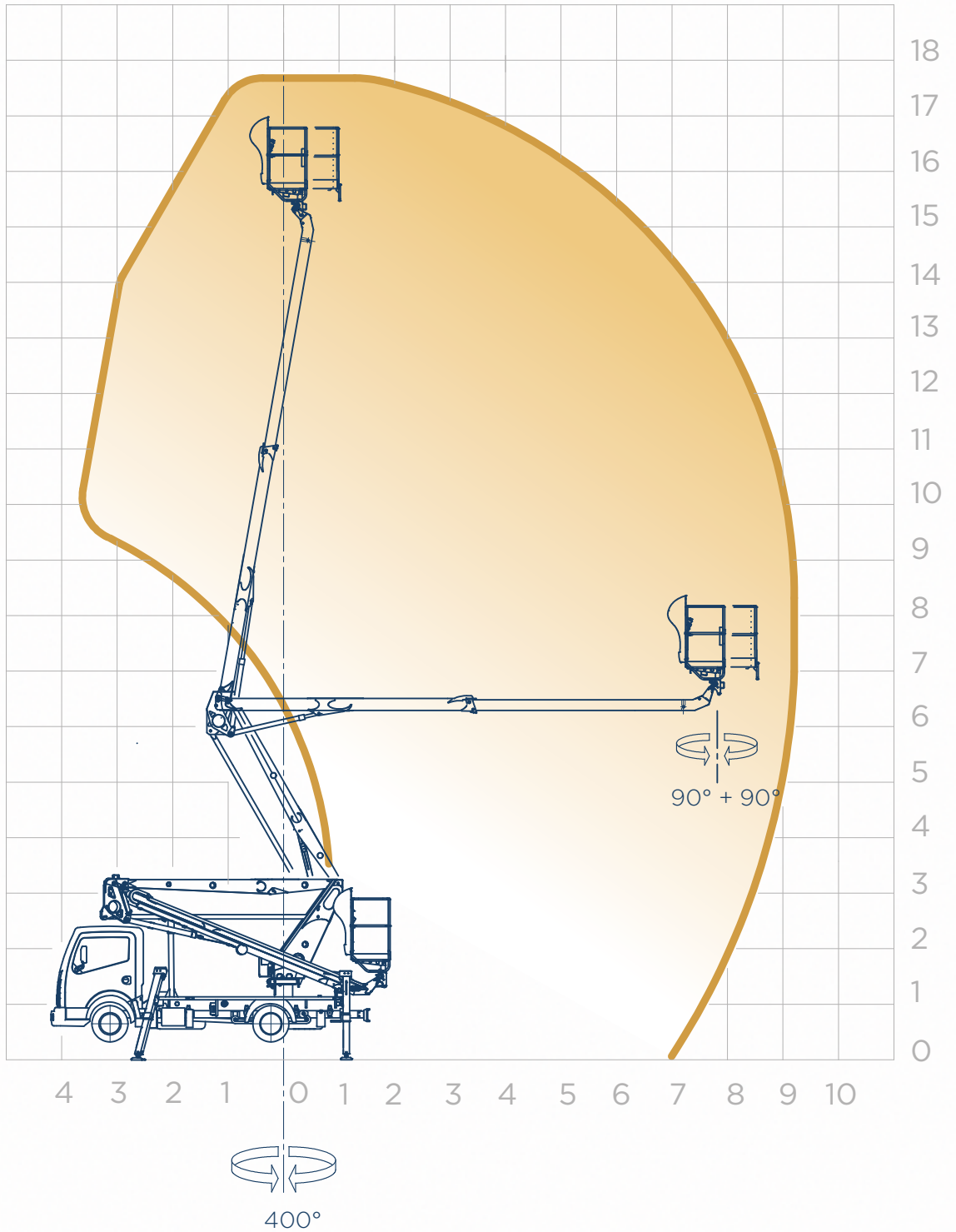

Legend / Légende Legende / Legende

	max working height hauteur mas de travail max arbeitshöhe werkhoogte				standing engine height hauteur à repos höhe in ruhestellung hoogte in ruststand
	platform floor height hauteur du plan de la nacelle höhe der trittfläche werkvloerhoogte				standing engine length longeur à repos länge in ruhestellung lengte in ruststand
	max working outreach déport max de travail max auskragung bei arbeit maximaal werkbereik				standing engine width largeur à repos breite in ruhestellung breedte in ruststand
	max load capacity capacité maximum max. Belastbarkeit max. draagvermogen				
	slewing turret rotation de la tourelle rotation des aufbaus rotatie bovenstel		engine moteur motor motor		hydraulically-extendible tracked truck chariot chenillé à élargissement hydraulique Hydraulisch verbreiterbarer Raupenkettewagen hydraulisch uitschuifbare rupswagen
	platform plate-form arbeitsbühne werkkorf		machine weight poids machine gewicht der machine machinegewicht		electrical system voltage tension du système spannung der elektroanlage spanning elektrische inrichting
	controls commandes bedienvorrichtungen bedieningen		traction / max traslation speed traction / vitesse max de translation maximal verfahrsgeschwindigkeit trekkracht / max. verplaatsingsnelheid		oil tank capacity capacité du réservoir d'huile fassungsvermögen behälter oil inhoud olietank
	max wind speed vitesse max du vent windgeschwindigkeit max windsnelheid op hoogte		slewing platform rotation plate-form rotation der arbeitsböhne korf rotatie		pantograph pantographe pantograph pantograaf
	fixed or rotating jib jib fixe ou pivotant Ortsfester oder drehbarer Jib vaste of roterende jib		boom bras opérateur arbeitskragarm werkarm		stabilisation stabilisation stabilisierung stabilisatie
	jib extension extension du jib jib ausdehnung jib zwenkbereik		boom bras opérateur arbeitskragarm werkarm		minimum installation installation minime mindestinstallation minimum installatie
	jib angle angle du jib jib winkel jib hoek		boom bras opérateur arbeitskragarm werkarm		minimum installation installation minime mindestinstallation minimum installatie

225 kg



Specifications / Spécifications
Spezifikationen / Specificaties

	17,8 m
	15,8 m
	9,2 m
	225 kg
	double bar, all steel barre double, en acier dopplebarren stahl dubbel gelaagd staal
	400°
	1400x700x h1100 mm aluminium 1400x700x h1100 mm aluminium 1400x700x h1100 mm alu 1400x700x h1100 mm aluminium
	90° right + 90° left 90° droite + 90° gauche 90° re + 90° li 90° rechts + 90° links
	proportional hydraulic type hydrauliques proportionnelles hydraulisch proportional porportioneel hydraulisch type
	2990 mm
	6100 mm
	2200 mm
	type A type A type A type A
	3,5 t

snake 2112







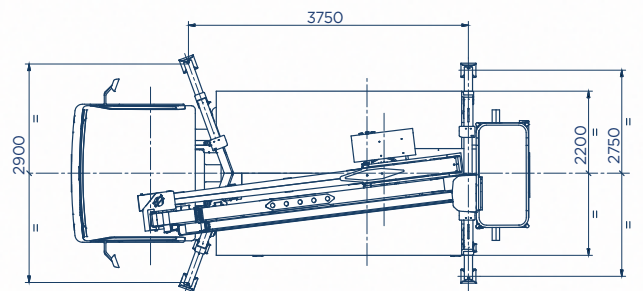
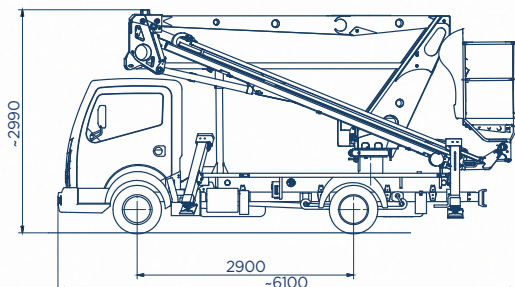
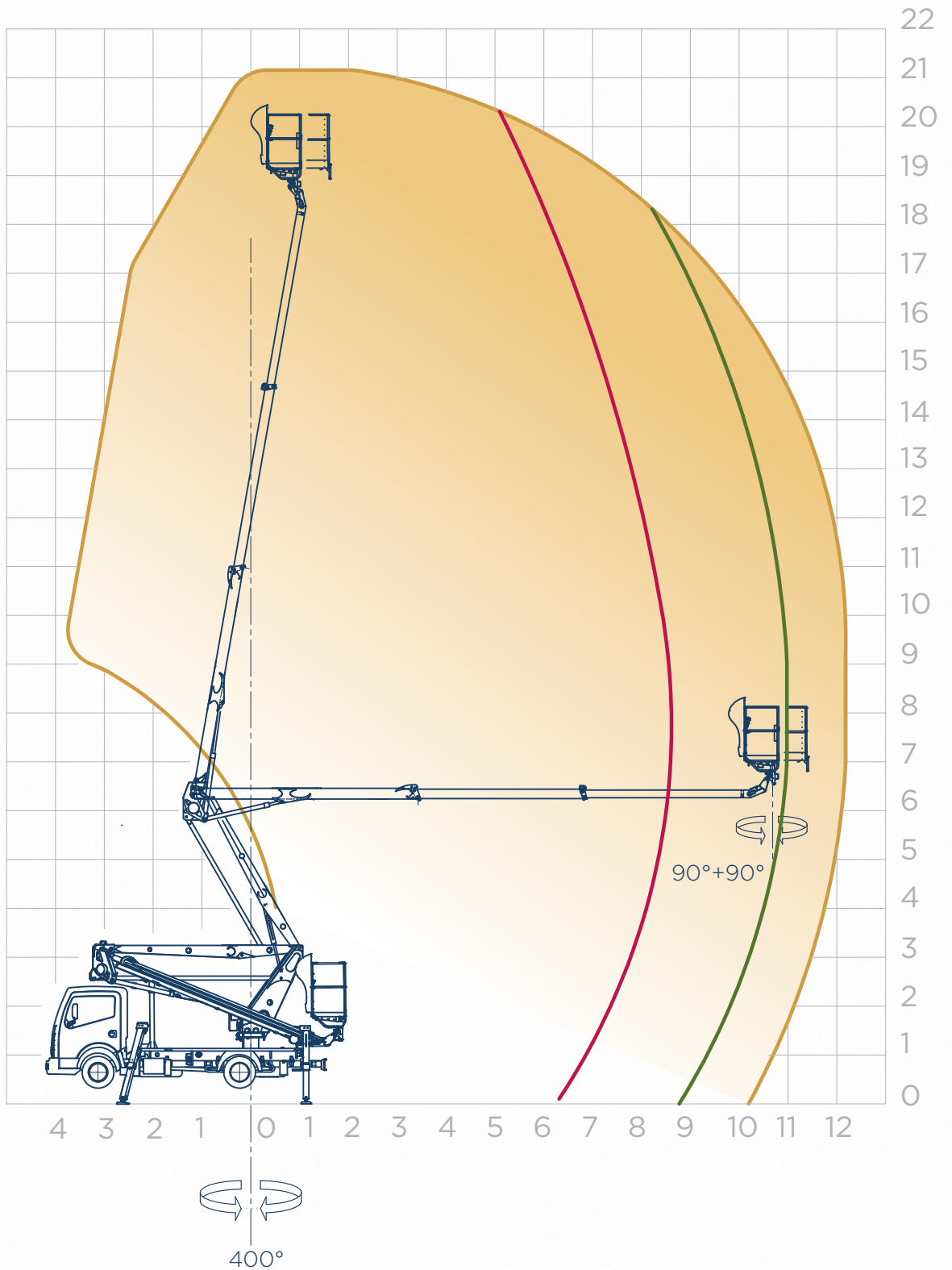







80 kg

120 kg

225 kg





Specifications / Spécifications
Spezifikationen / Specificaties





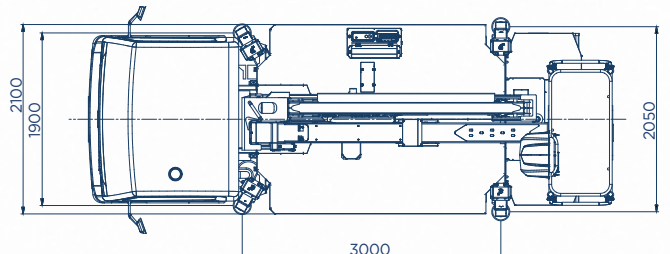
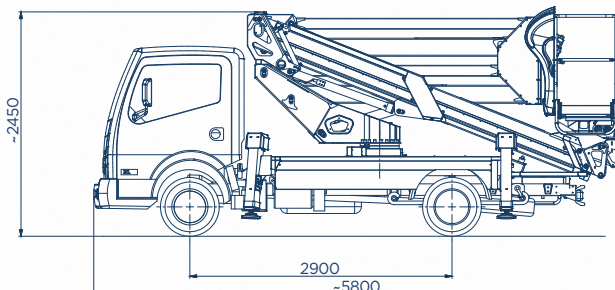
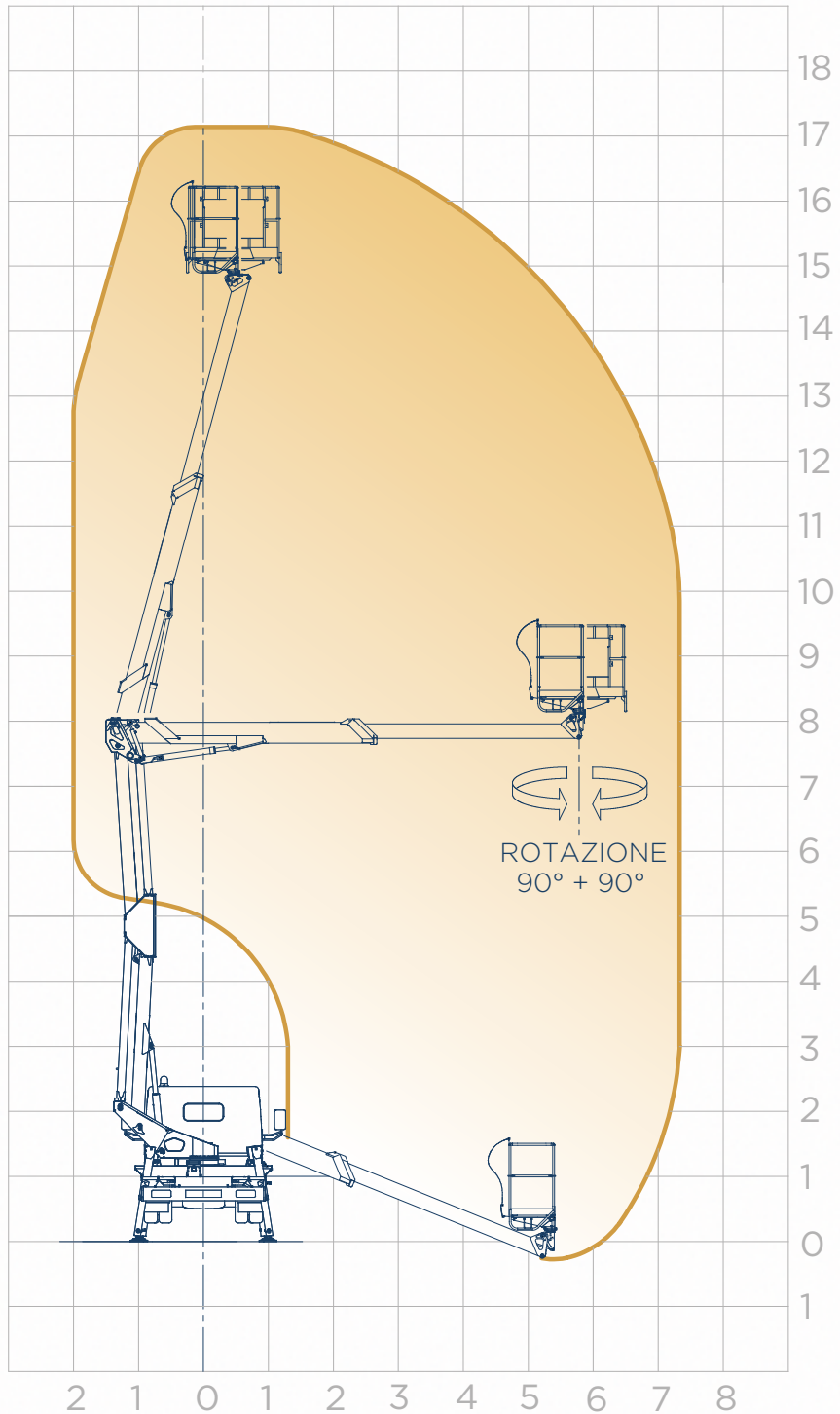









	21,2 m
	19,2 m
	12 m
	225 kg
	double bar, all steel barre double, en acier dopplebarren stahl dubbel gelaagd staal
	400°
	1400x700x h1100 mm aluminium 1400x700x h1100 mm aluminium 1400x700x h1100 mm alu 1400x700x h1100 mm aluminium
	90° right + 90° left 90° droite + 90° gauche 90° re + 90° li 90° rechts + 90° links
	proportional hydraulic type hydrauliques proportionnelles hydraulisch proportional porportioneel hydraulisch type
	2990 mm
	6100 mm
	2200 mm
	type A type A type A type A
	3,5 t

snake 1770 plus

220 kg



Specifications / Spécifications
Spezifikationen / Specificaties

	17,2 m
	15,2 m
	7,3 m
	220 kg
	double bar, all steel barre double, en acier dopplebarren stahl dubbel gelaagd staal
	350°
	1400x700x h1100 mm aluminium 1400x700x h1100 mm aluminium 1400x700x h1100 mm alu 1400x700x h1100 mm aluminium
	90° right + 90° left 90° droite + 90° gauche 90° re + 90° li 90° rechts + 90° links
	proportional hydraulic type hydrauliques proportionnelles hydraulisch proportional porportioneel hydraulisch type
	2450 mm
	5800 mm
	2100 mm
	closed shape type dans le gabarit abstützung in fahrzeugbreite gesloten vrom
	3,5 t

snake 2010 plus

120 kg



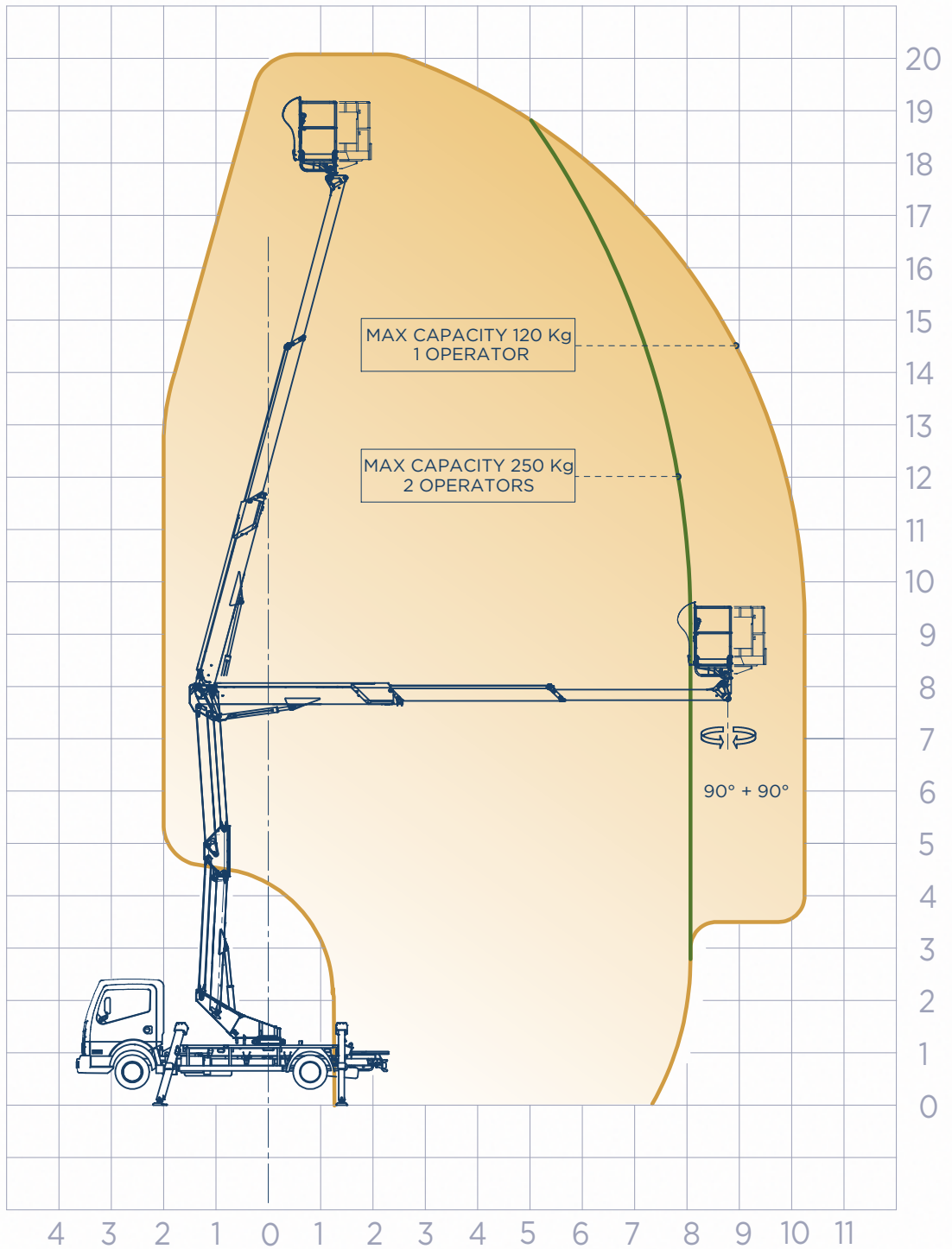

250 kg

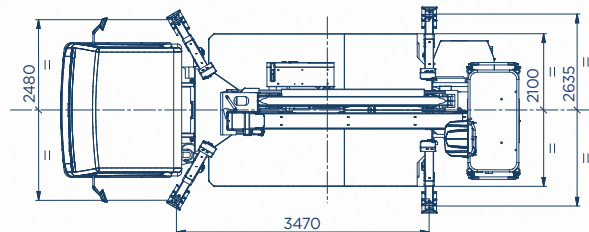
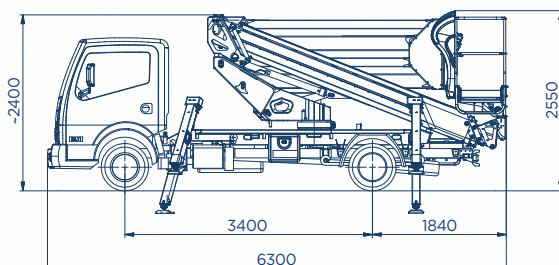

Disponibile con comandi elettroidraulici
 Available with electro-hydraulic controls
 Disponible con mandos electro hidráulico
 Доступны с электрогидравлических управления



Specifications / Spécifications
Spezifikationen / Specificaties

	20 m
	18 m
	10 m
	250 kg
	double bar, all steel barre double, en acier dopplebarren stahl dubbel gelaagd staal
	355°
	1400x700x h1100 mm aluminium 1400x700x h1100 mm aluminium 1400x700x h1100 mm alu 1400x700x h1100 mm aluminium
	90° right + 90° left 90° droite + 90° gauche 90° re + 90° li 90° rechts + 90° links
	proportional hydraulic type - version, electro-hydraulic controlled aerial part-hydraulic stabilization hydrauliques proportionnelles - parties aériennes électrohydrauliques – stabilisation hydraulique hydraulisch proportional - elektrohydraulisch gehobener Teil - hydraulische Stabilisierung porportioneel hydraulisch type - versie luchtdeel elektro-hydraulische bedieningen - hydraulische stabilisatie
	2550 mm
	6300 mm
	2100 mm
	type A type A type A type A
	3,5 t

snake 2010 H plus



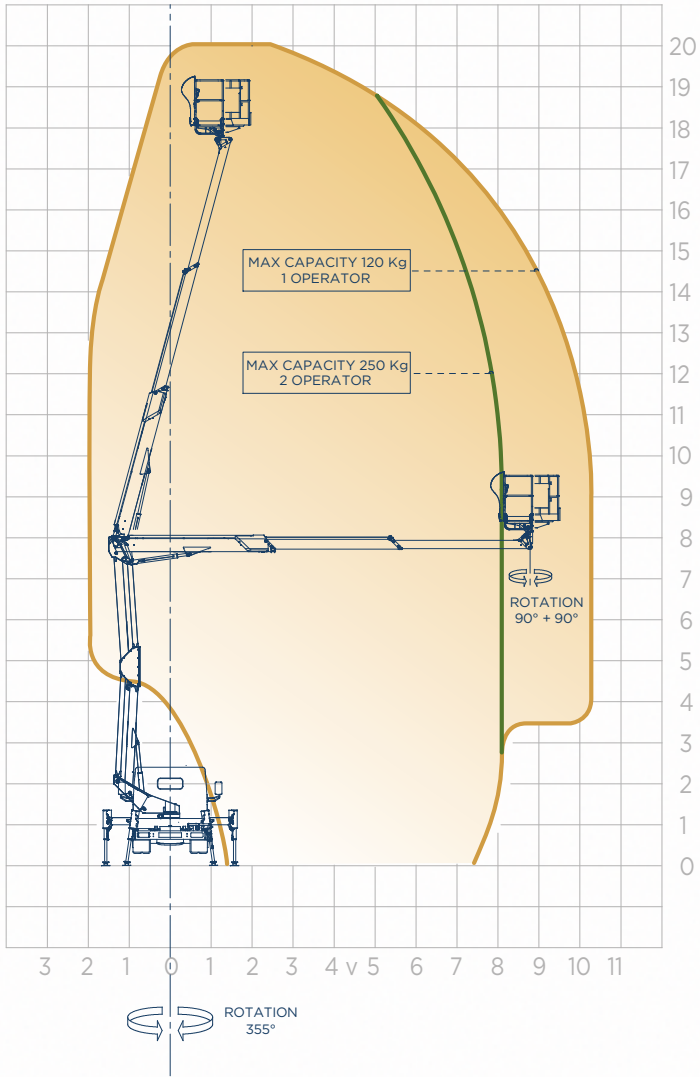

Open outriggers

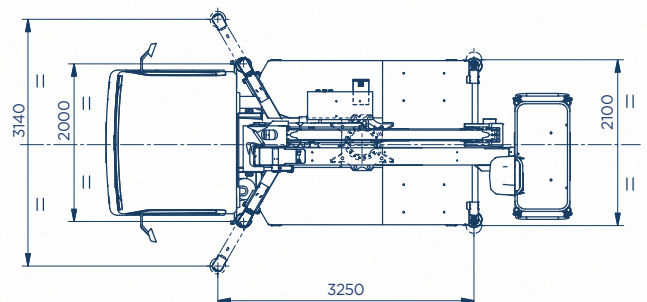
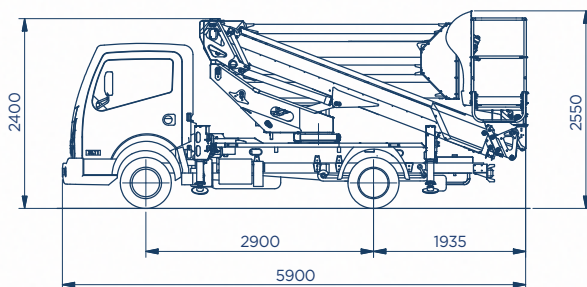
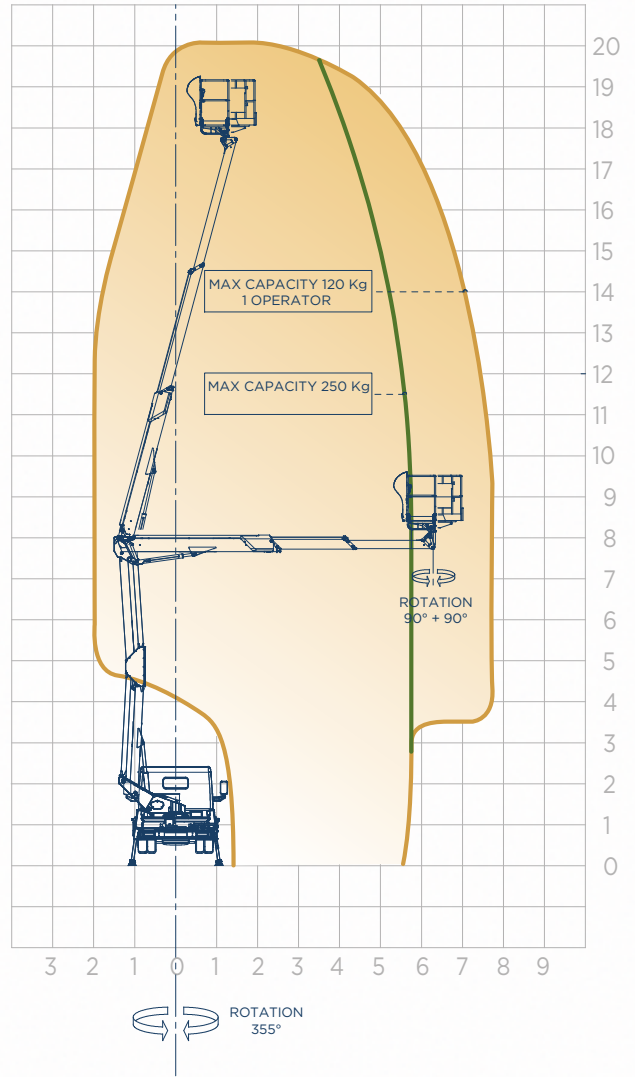

Closed outriggers



Specifications / Spécifications
Spezifikationen / Specificaties

	20 m
	18 m
	10 m
	250 kg
	double bar, all steel barre double, en acier dopplebarren stahl dubbel gelaagd staal
	355°
	1400x700x h1100 mm aluminium 1400x700x h1100 mm aluminium 1400x700x h1100 mm alu 1400x700x h1100 mm aluminium
	90° right + 90° left 90° droite + 90° gauche 90° re + 90° li 90° rechts + 90° links
	proportional hydraulic type - version, electro-hydraulic controlled aerial part-hydraulic stabilization hydrauliques proportionnelles - parties aériennes électrohydrauliques – stabilisation hydraulique hydraulisch proportional - elektrohydraulisch gehobener Teil - hydraulische Stabilisierung porportioneel hydraulisch type - versie luchtdeel elektro-hydraulische bedieningen - hydraulische stabilisatie
	2550 mm
	5900 mm
	2100 mm
	type H type H type H type H
	3,5 t

snake 2413 plus

Area with opened outriggers

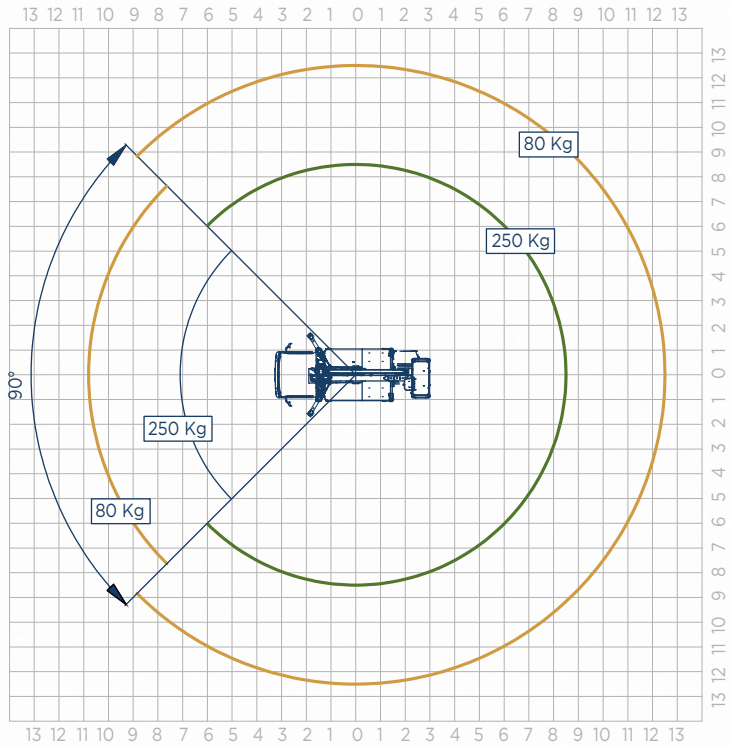
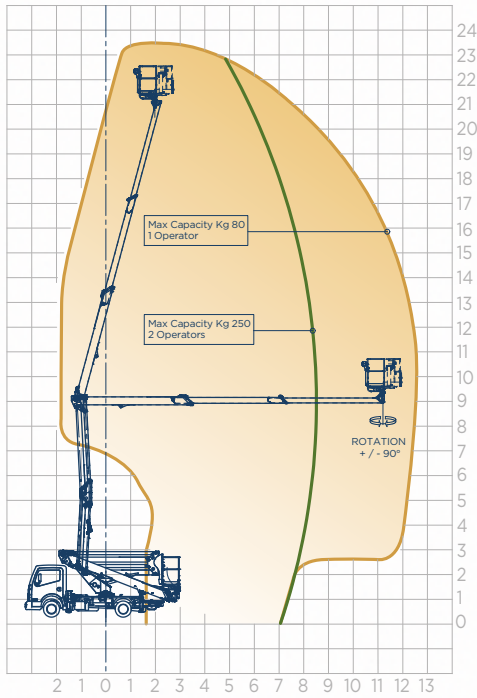

Area with closed outriggers

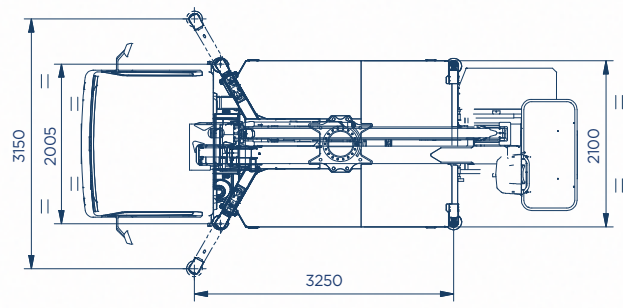
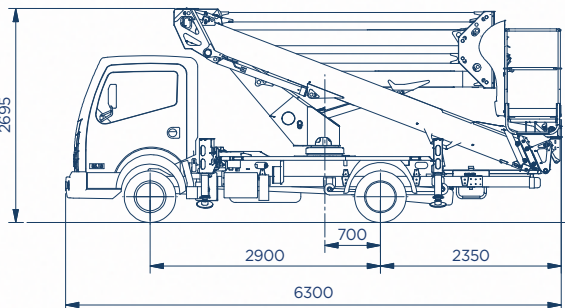
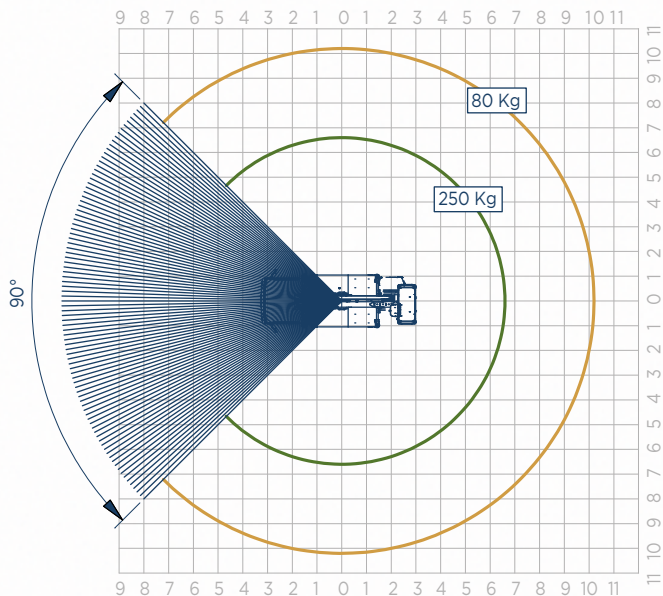
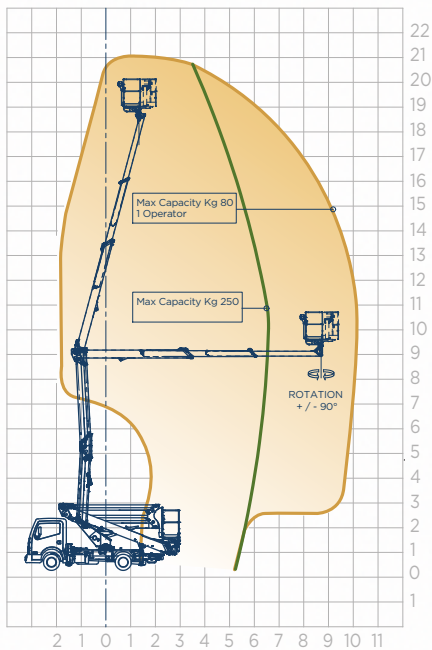

Specifications / Spécifications
Spezifikationen / Specificaties

	23,5 m
	21,5 m
	12,6 m
	250 kg
	double bar, all steel barre double, en acier dopplebarren stahl dubbel gelaagd staal
	400°
	1400x700x h1100 mm aluminium 1400x700x h1100 mm aluminium 1400x700x h1100 mm alu 1400x700x h1100 mm aluminium
	90° right + 90° left 90° droite + 90° gauche 90° re + 90° li 90° rechts + 90° links
	Aerial part: electro-hydraulic – Stabilization: electro-hydraulic (or hydraulic) partie aérienne: hydrauliques - stabilisation: électro-hydrauliques (ou hydrauliques) In der Höhe befindlicher Teil: hydraulisch - Stabilisierung: elektrohydraulisch (oder hydraulisch) hoog deel: hydraulisch - stabilisatie: elektrohydraulisch (of hydraulisch)
	2730 mm
	6300 mm
	2100 mm
	type H type H type H type H
	3,5 t







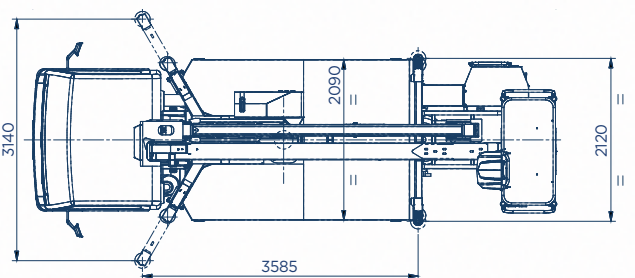
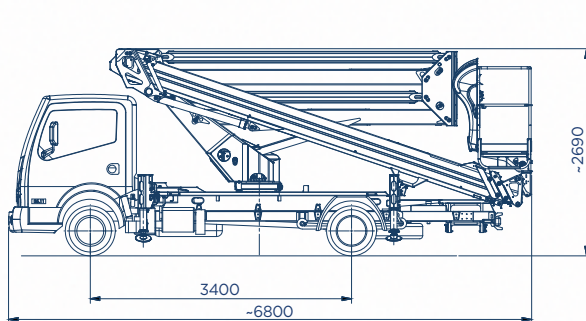
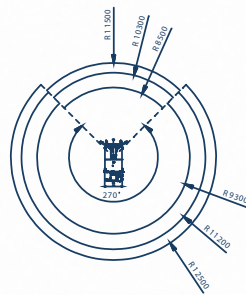
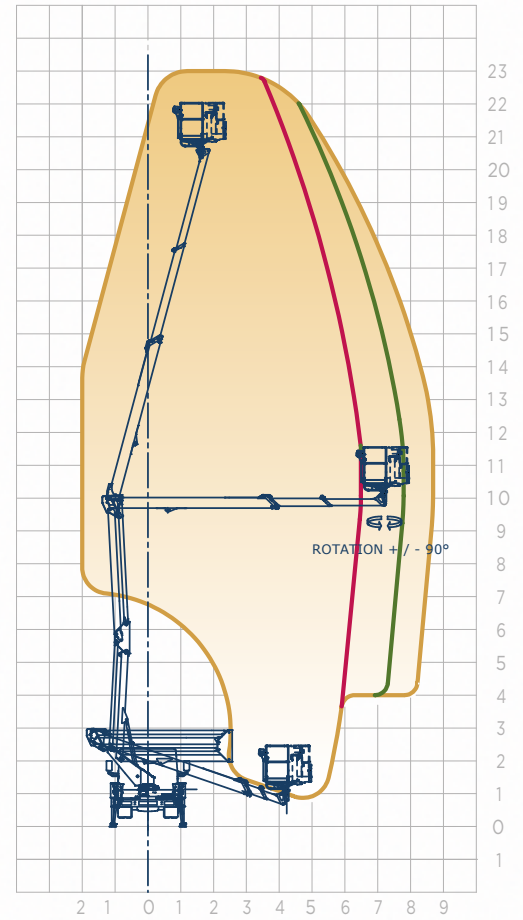
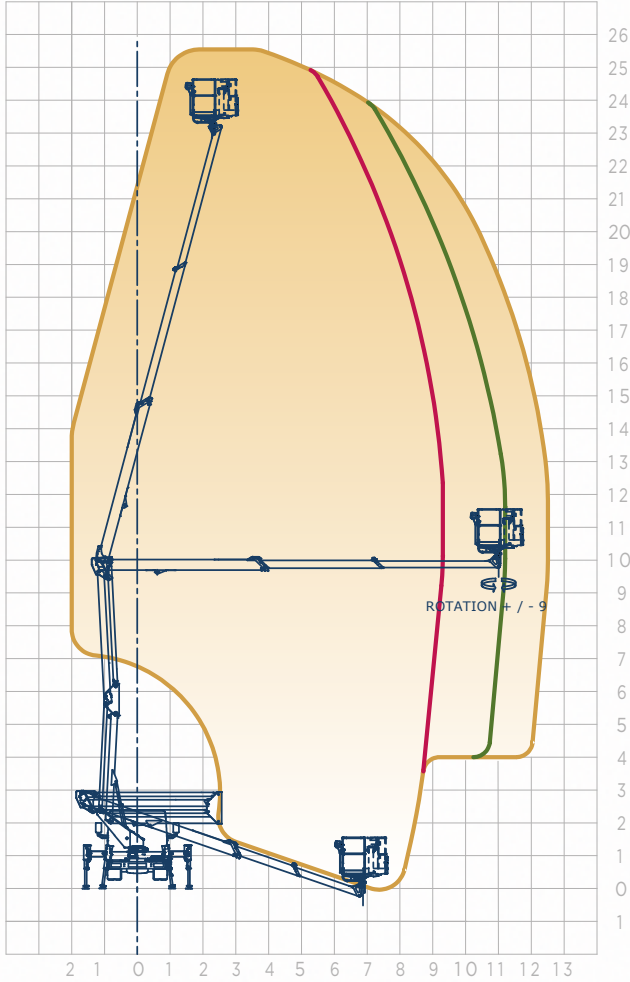





snake 2612 plus

Open outriggers

Closed outriggers



Specifications / Spécifications
Spezifikationen / Specificaties

	25,6 m
	23,6 m
	12,2 m
	200 kg
	double bar, all steel barre double, en acier dopplebarren stahl dubbel gelaagd staal
	355°
	1400x700x h1100 mm aluminium 1400x700x h1100 mm aluminium 1400x700x h1100 mm alu 1400x700x h1100 mm aluminium
	90° right + 90° left 90° droite + 90° gauche 90° re + 90° li 90° rechts + 90° links
	electro-hydraulic électrohydrauliques elektrohydraulisch elektro-hydraulische
	2690 mm
	6800 mm
	2100 mm
	type H type H type H type H
	3,5 t

snake 2815 plus

Open outriggers

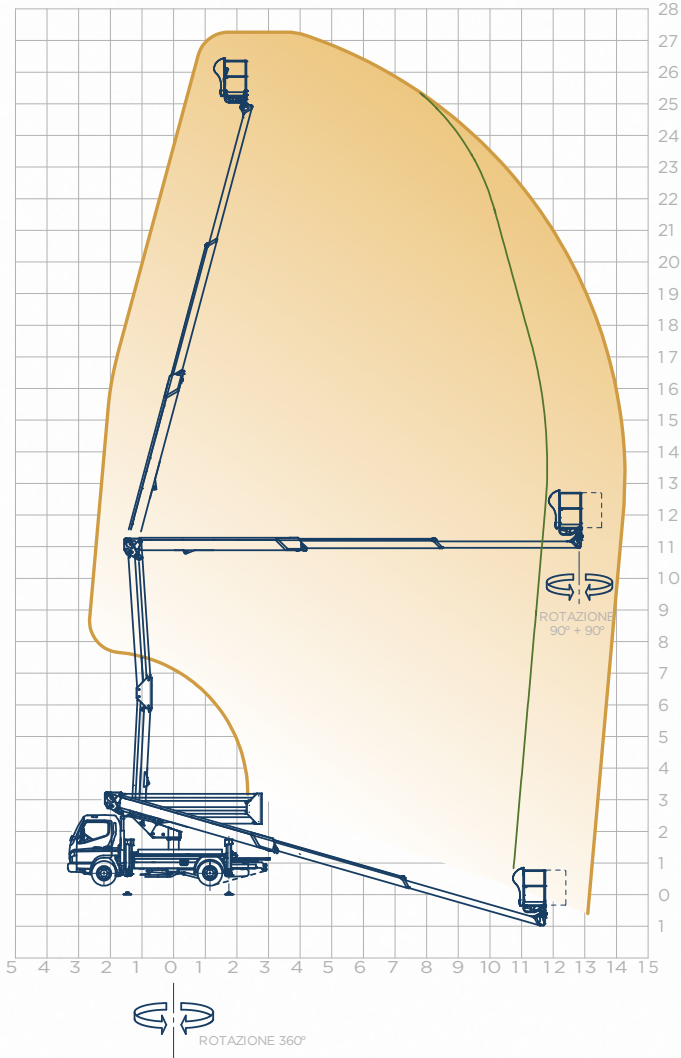

120 kg

230 kg

Closed outriggers

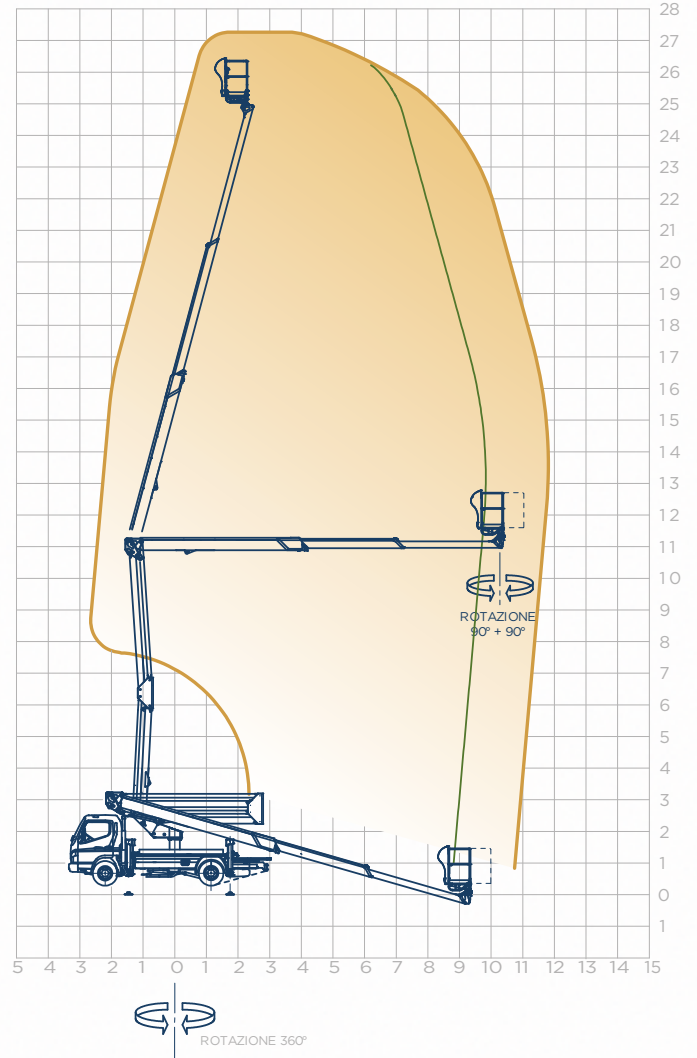





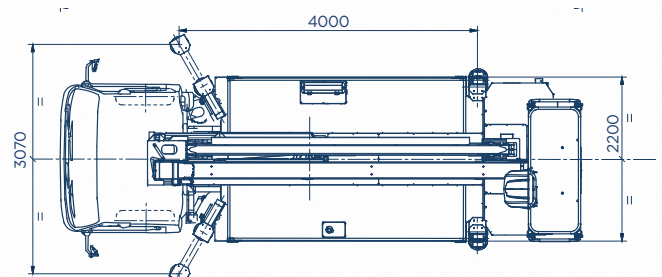
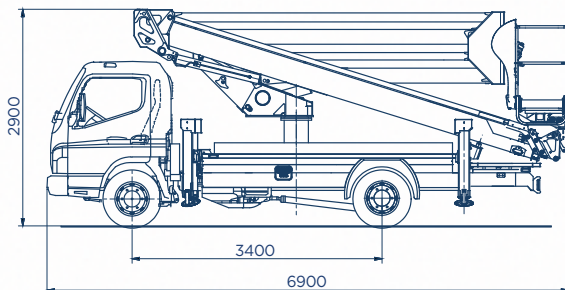







120 kg

230 kg



Specifications / Spécifications
Spezifikationen / Specificaties

	27,3 m
	25,3 m
	14,5 m
	230 kg
	double bar, all steel barre double, en acier dopplebarren stahl dubbel gelaagd staal
	360°
	1700x700x h1100 mm aluminium 1700x700x h1100 mm aluminium 1700x700x h1100 mm alu 1700x700x h1100 mm aluminium
	90° right + 90° left 90° droite + 90° gauche 90° re + 90° li 90° rechts + 90° links
	proportional hydraulic type hydrauliques proportionnelles hydraulisch proportional porportioneel hydraulisch type
	2900 mm
	6900 mm
	2200 mm
	type H type H type H type H
	6 t

Technical data, descriptions and illustrations are merely indicative and not binding.
Oil&Steel reserve the right to update them without notice.

Les données techniques, descriptions et illustrations sont seulement indicatives et non contractuelles.
Oil&Steel se réserve le droit de les modifier sans préavis.

Technische Daten, Beschreibungen und Bilder sind nur hinweisend und nicht verbindlich.
Oil&Steel kann sich das Recht vorbehalten, sie fristlos zu aktualisieren.

Specificaties, beschrijvingen en foto's zijn slechts indicatief en niet bindend.
Oil & Steel kan zich het recht om ze te updaten zonder voorafgaande kennisgeving te reserveren.

OIL & STEEL

AERIAL PLATFORMS

www.oilsteel.com

OIL&STEEL spa
via G. Verdi 22
41018 S. Cesario sul Panaro
Modena Italy
tel +39 059 936811
fax +39 059 936413



OIL&STEEL
is a company of
Manitex International

